

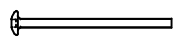

1





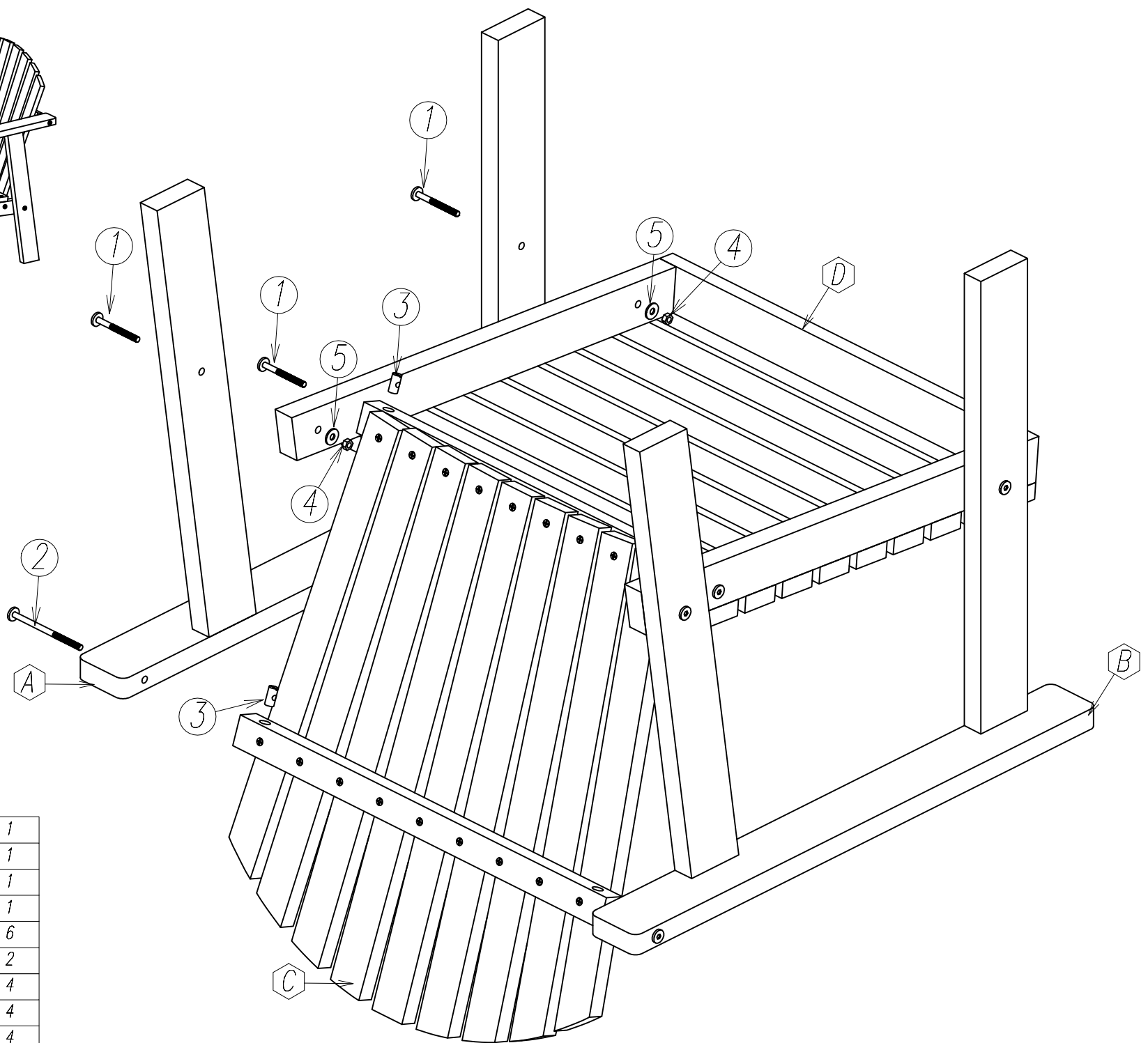
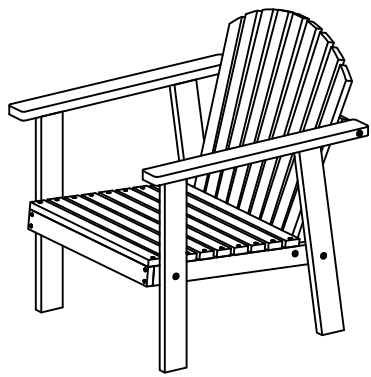

2

- A x2
- B x2
- C x1





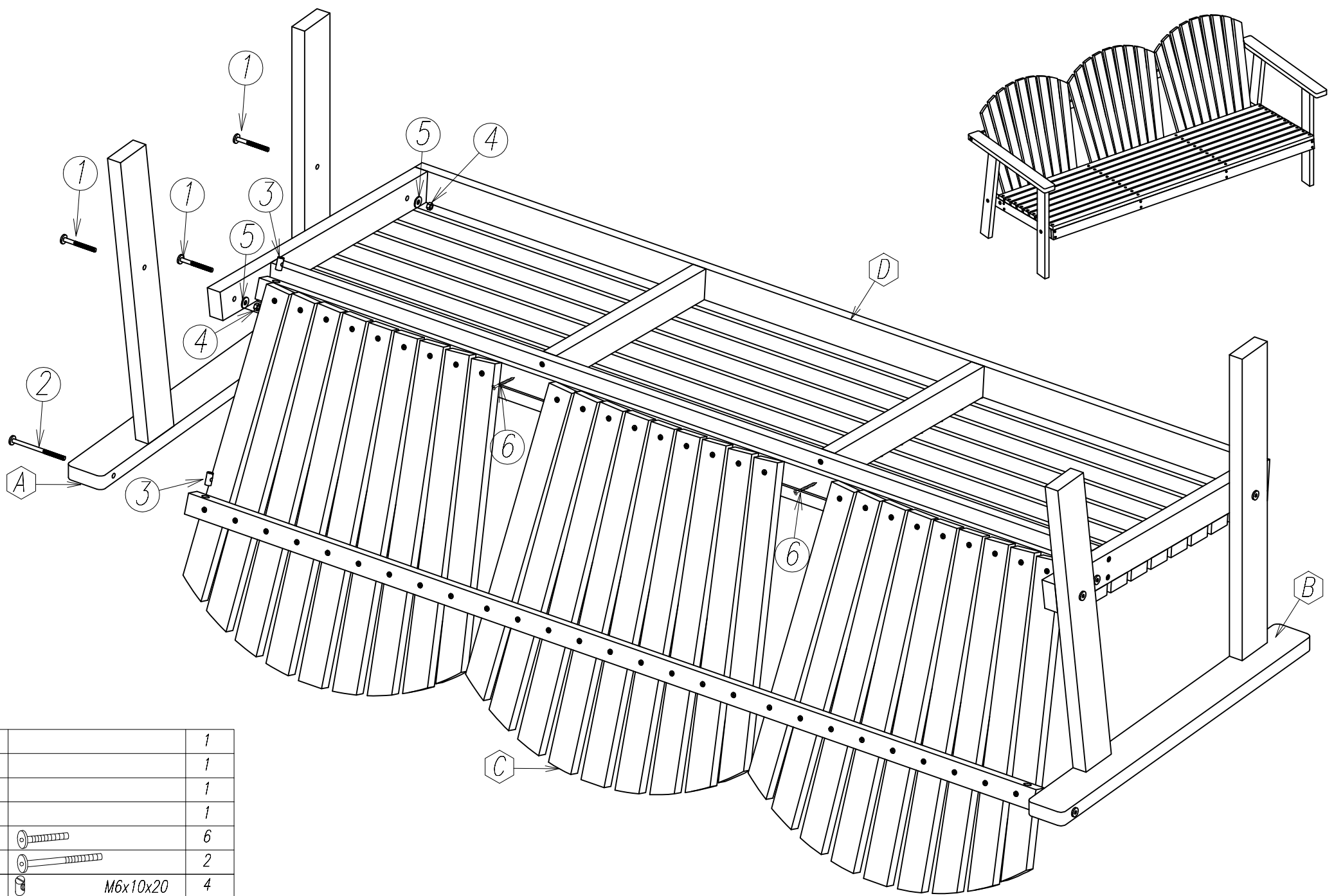

1		8
2		4
3		1

! Do not tighten any bolts until table top has been placed

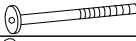

A		1
B		1
C		1
D		1
1		6
2		2
3	 M6x10x20	4
4	 M6	4
5	 M6	4
6		1



A		1
B		1
C		1
D		1
1		6
2		2
3	 M6x10x20	4
4	 M6	4
5	 M6	4
6		2
7		1