

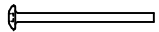





- A x1
- B x4
- C x2

1		M6x40	4
2			2
3		M6x45	2
4			1

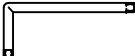
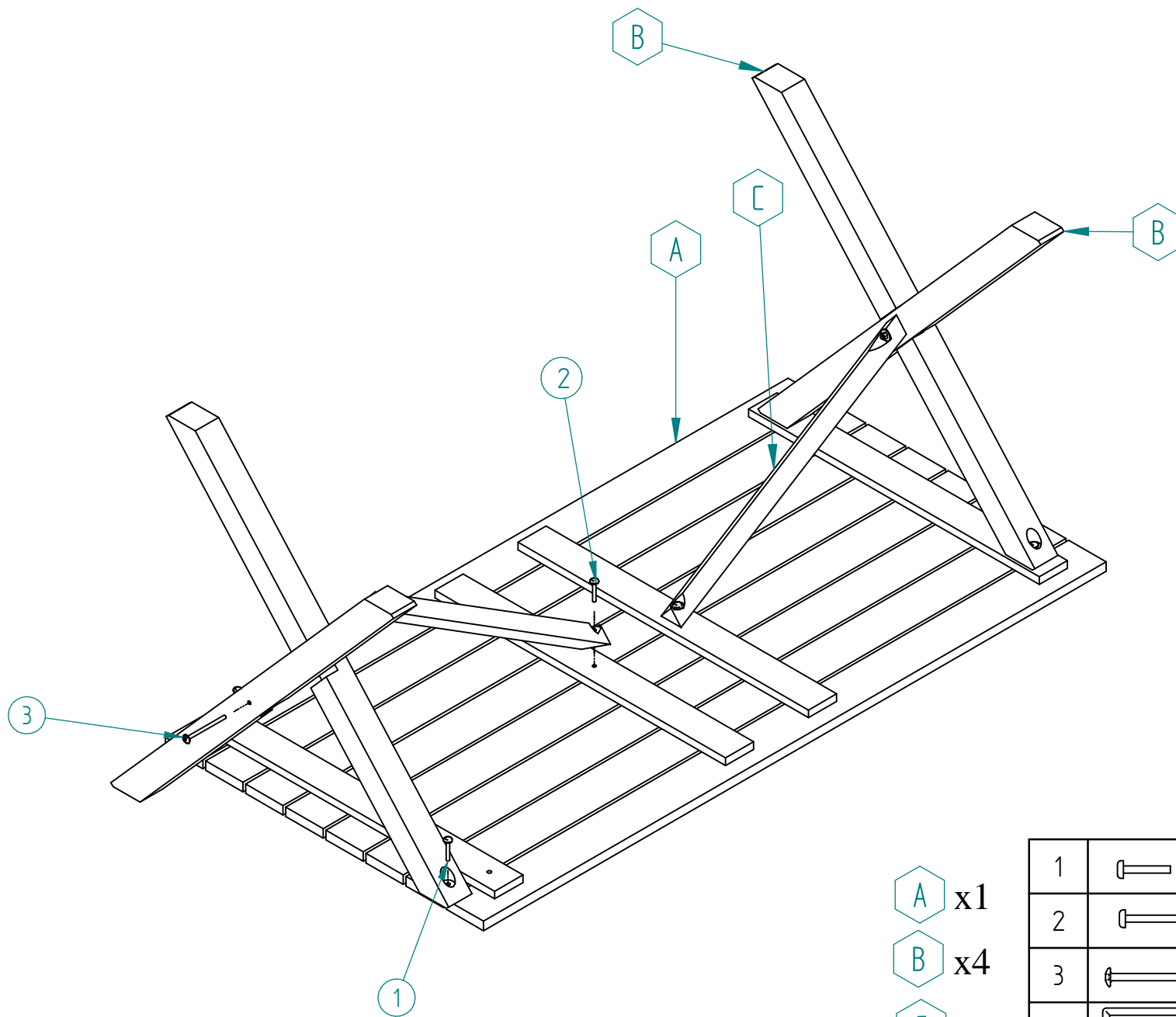

- A** x1
- B** x4
- C** x2

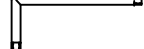
1		6x40	4
2		6x50	2
3		6x90	2
4			1